

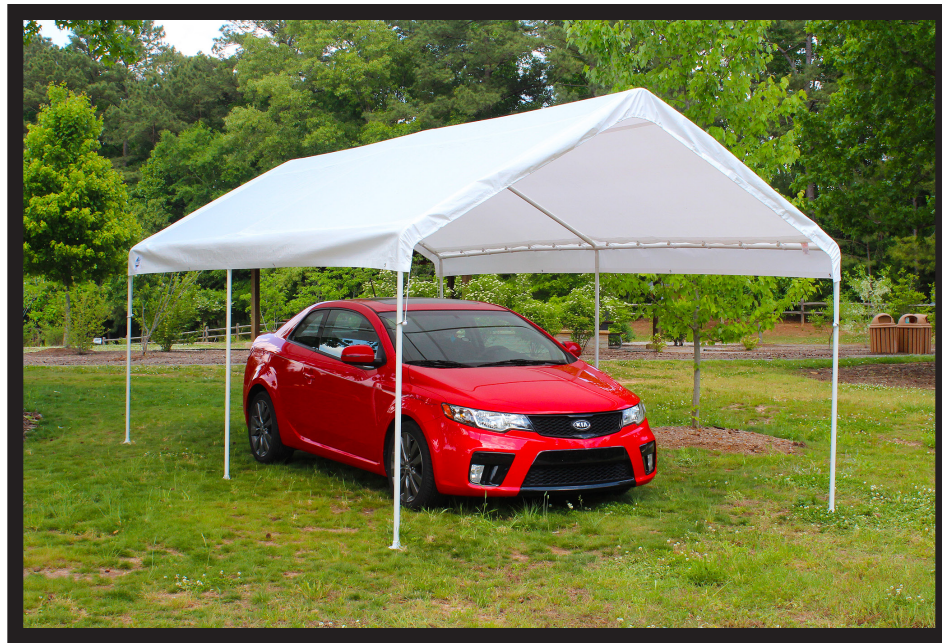

Universal™ 10ft X 20ft

10ft8in Wide x 20ft Deep x 5ft10in Side Height /
8ft11in Center Height



King Canopy Item #: C61020PC

With 6 Legs, White Drawstring Cover,
Elastic Ball Straps & Foot Pads.









Distributed by:
PIC America, LTD.
8009 Purfoy Road • Fuquay-Varina, NC 27526
1-800-800-6296 • www.kingcanopy.com

WARNING:

Keep all flame and heat sources away from this tent fabric. Meets the flammability requirements of CPAI-84 Sec 6 and NFPA 701 It is not fire proof. The fabric will burn if left in continuous contact with any flame source.

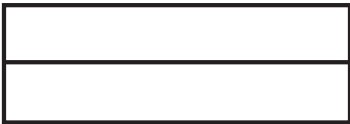

PARTS LIST

5X8PC	18 pc	68" Powder Coated Pipe	
4X6PC	6 pc	52" Swaged Powder Coated Pipe	
3WPC	6 pc	3-Way Connectors	
4WPC	3 pc	4-Way Connectors	
BALLW	44 pc	Elastic Ball Straps	
PFOOT	6 pc	Plastic Foot Pads	
TDS10206-5	1 pc	White Drawstring Cover	
CCLIP	4 pc	Curtain Clips	

FRAME ASSEMBLY



Step 1

Place all corners and pipe on the ground as shown. The 52" swaged pipes are used to form the length of the canopy.

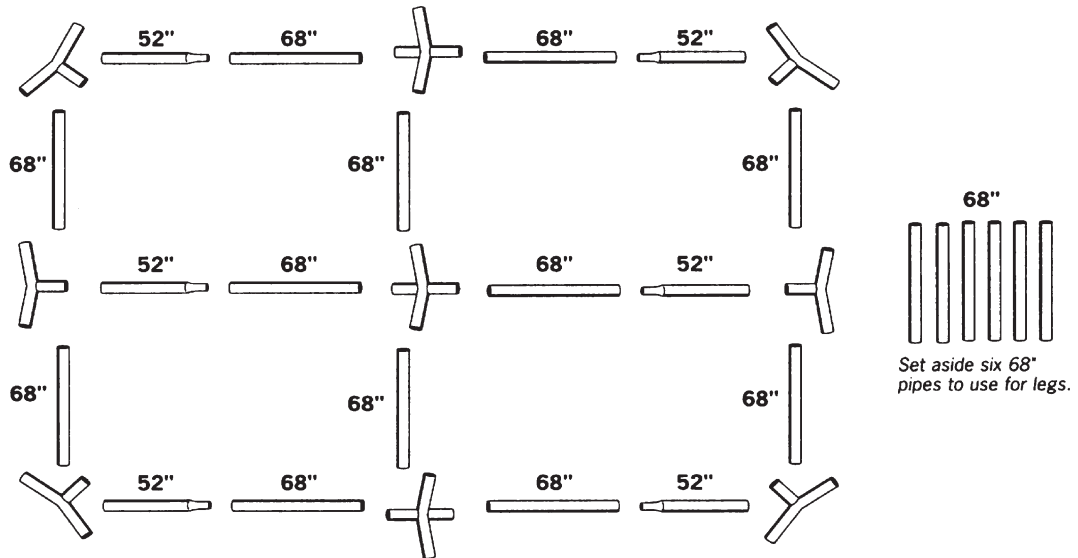

Step 2

Start with the center and complete the center frame first. Then assemble each side.

NOTE: Attach the cover before inserting the legs.

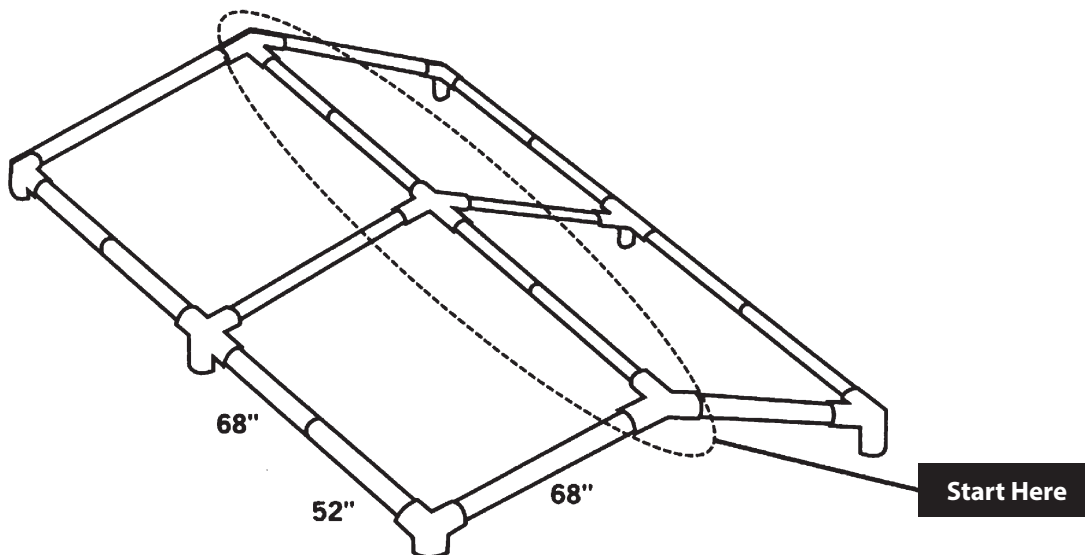



COVER ASSEMBLY

Step 1

Unfold the cover with the grommets toward the cover's bottom and place over the frame.

Step 2

Begin attaching the cover with the elastic ball straps by inserting the elastic cord of the ball strap underneath the cover and through the grommet. Then pull cord taut until ball stops. Wrap the cord around the pole and under the ball. This will hide the ball under the cover and provide a more finished look to your unit.

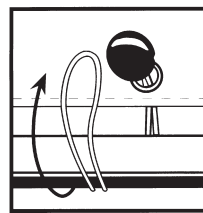

Inside View

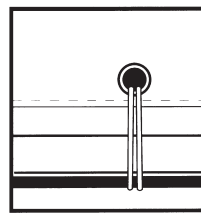

Outside View

- Start by attaching 2 elastic ball straps at each of the four corners
- Continue attaching straps from left to right in a zigzag pattern down both sides of the canopy
- Attach straps at the front and back of the unit, again using a zigzag pattern until all straps are secured

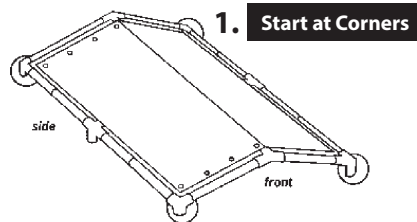

2. Go Left to Right

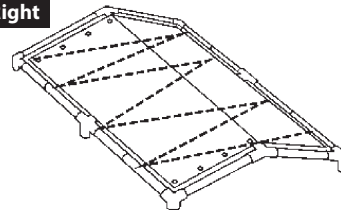

3. Go Front to Back

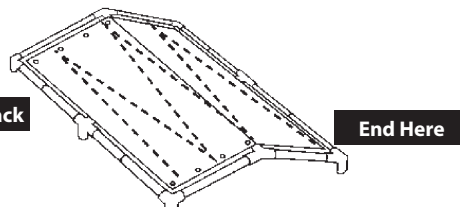

Note:

The ball straps are long enough to accommodate various cover lengths. If your straps need a tighter fit, they can be shortened by making an additional knot in the cord strap. Slide the ball upward to reveal the tied knot. Tie a new knot above the old one. The size of the knot will determine how short the strap becomes. Slip the ball down over the new knot and secure.

LEGS ASSEMBLY



NOW, CONNECT THE LEG POLES TO THE ROOF ASSEMBLY WITH THE COVER ALREADY POSITIONED ON TOP OF THE UNIT.

Step A: First insert the pipes for the middle poles into the 3- and 4-way connectors, and then connect the end leg pipes in the same way. (See illustration)

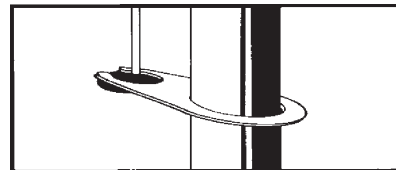

Step B: Slip one clip onto each of the corner legs.

Step C: Push the foot pads onto the bottom of each leg.

NOTE: The foot pads are NOT for anchoring the canopy!

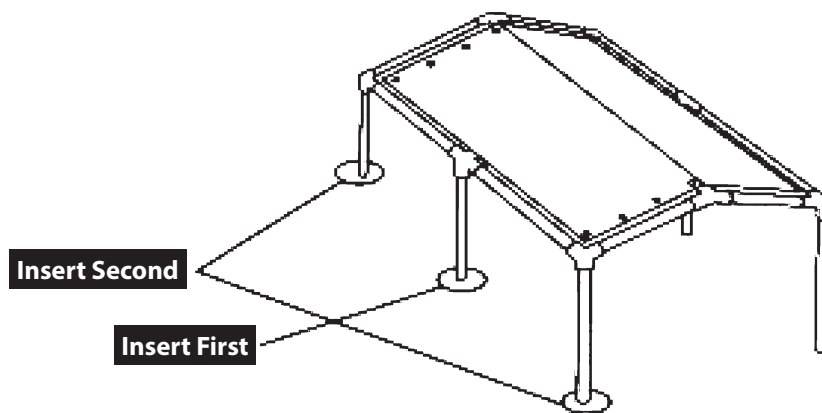

To secure the clips on the corner legs use the drawstring sewn into each end of the cover. Adjust the drawstring evenly on each side of the canopy by pulling the drawstrings on each end of the cover at the same time. Insert the ball on the drawstring into the slot on the curtain clip. Pull the clip down until tight. Pressure from the drawstring will cause the clip to wedge onto the pipe.

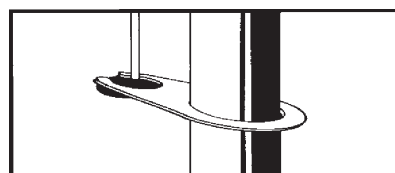

Curtain clips may have to be re-tightened occasionally due to strong wind gusts. IMPORTANT! Once the legs and cover are assembled, your canopy will act like a kite in the wind. It is imperative that the canopy anchors be installed NOW!



ANCHORING YOUR UNIT

This canopy is designed for use as a temporary structure. After assembly, the canopy **MUST BE** securely anchored to the ground to prevent damage from winds. Your canopy will act like a kite in the wind if not properly and securely anchored to the ground. Severe winds will cause the frame to twist and unanchored legs will fall, thereby collapsing the canopy. If severe winds are expected, you must remove the cover from the frame to prevent damage.

Step 1

Measure out at least 36in from each leg. Screw each anchor into the ground leaving 2in between the ground and the eye of each anchor. We strongly recommend that your unit be anchored 36in from each leg although this may not be possible in all cases. **DO** install anchors as close to 36in away from legs as possible.

Step 2

Tie anchor cable or rope around the connector at the top of each leg of the canopy.

Step 3

Securely tie the other end of the cable or rope through the eye of the anchor and pull tight.

Step 4

Now, continue to screw each anchor into the ground until the eye of the anchor is flush with the ground. This will secure the anchor rope even tighter.

NOTE: You should check and tighten the rope frequently to ensure maximum stability of your canopy and to protect against wind damage.

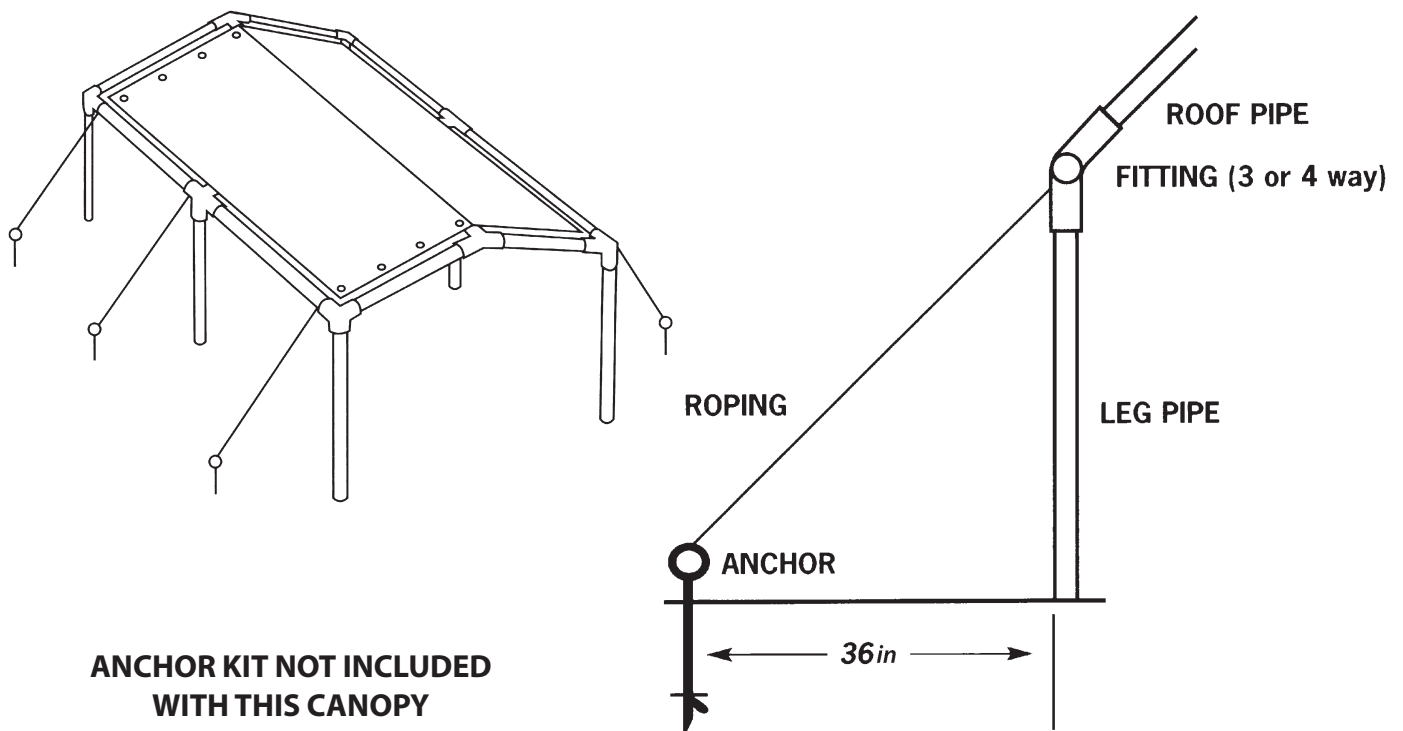

IMPORTANT NOTICE: PLEASE READ CAREFULLY



We are confident that you will be completely satisfied with your King Canopy unit. Please take a moment to read the very important information below, and call us with any questions you may have.

King Canopy/PIC America, LTD. has no control over wind, snow, ice, rain or any other weather condition and we are in no way responsible for any damage caused by the canopy or to the canopy. We suggest you contact your insurance carrier just as you would for any other outside structure.

OTHER PRECAUTIONS WHICH MUST BE FOLLOWED:

Keep all flame and heat sources away from this tent fabric. The tent fabric will burn if left in continuous contact with any flame source.

DO NOT cook underneath or near canopy.

DO NOT store or use flammable liquids underneath or near canopy.

DO NOT ignite or store fireworks underneath or near canopy.

DO NOT use bleach to clean cover.

DO NOT dry clean cover.

DO NOT wash cover in washing machine or dry in dryer. Hand wash with mild soap and water only.

DO NOT allow rain water, snow or ice to accumulate on top of cover.

DO NOT hang or suspend anything from the frame, grommets, truss system or ball straps of the unit.

REMOVE canopy cover before a storm, or disassemble entire canopy unit if possible.

REMOVE rain water, snow and ice from canopy cover.

This is a temporary structure and is not recommended for use as a permanent structure.



PRODUCT INFORMATION

Missing/Defective Parts

We try our best to eliminate any defective parts that are shipped with our products. Carefully inspect all packages upon arrival and report any missing or defective items upon receipt. Any discrepancies must be reported to King Canopy within 30 days of purchase. Please be sure to take a few minutes to match all items in the box to the items on the product manual. If there should be any missing or defective items, we will ship them free of charge. You will need to e-mail information@kingcanopy.com with proof of purchase showing the date of your purchase and photos of the defective part. Your replacement will be shipped free of charge by ground shipping. Next day or express shipping will require freight collect and paid for by you. Damages from improper anchoring, strong winds, snow, ice, or rain are not considered defects.

1 Year Limited Warranty

All of our canopy components feature a 1-year limited warranty (90 day-limited on Value King Brand items) and are warranted to be free from defects in material and workmanship during this time frame. You must email us at information@kingcanopy.com and provide your proof of purchase receipt and photos of the defective part. This does not pertain to any missing or defective parts in 30 day inspection period.

Defective Returns

If you receive a product that is defective and you wish to return it, please contact our customer service department to receive a return authorization number. All items will be passed through quality control before issuing a credit. You will be contacted upon receipt of your returned merchandise and notified whether your return is accepted or not. If not, you will have the option to receive the product back at your expense.

Improper Anchoring, Strong Winds, Rain, Snow, Ice

King Canopy/ PIC America, LTD. does not guarantee these canopies under strong weather conditions (including snow & ice) under any circumstances. These canopies are designed to protect against damages caused by sun, light rain, tree sap, birds, etc. they are not designed to hold roof loads that accompany snow, ice, or heavy rains. If your canopy is anchored incorrectly and is blown away, we will not send any free replacement parts for damages. If you know strong weather is predicted- remove the cover or take down the unit completely. The cover is designed to be quickly and easily removed.

Non-Warranty Replacement Parts

If your warranty expires and you need replacement parts & they can't be found on www.kingcanopy.com, please contact us at 1.800.800.6296. We stock replacement parts for most of our products. Our customer service department will be pleased to assist you in any way possible. Certain regions of the country are extremely harsh on canopy covers. Normal wear & tear is not covered under warranty. In order to receive a replacement part, you may be asked to return the part, freight prepaid, to our warehouse for inspection before we will send a replacement. You must, in all cases, provide a copy of your receipt showing the date of purchase, model number and price.

Return Policy

All returns will require a return authorization number (RA). To obtain an RA, please contact our customer service department at 800.800.6296. All returns must be submitted before 30 days of purchase date, located on receipt. Any returns submitted after 30 days without an RA number will not be accepted. Credit will be issued upon receipt of product and inspected for damages or excessive wear and tear. The full amount of the product will be credited in the form of original payment minus a 25% restocking fee and shipping and handling.

Safety & Care Information

Always use your best judgment. **DO NOT** use canopy as a permanent cover. They are for **TEMPORARY USE ONLY**. Damages due to weather conditions are not warranted. **DO NOT** set up on a steep incline. Never set up in windy, rainy, or snowy conditions. Canopy is not intended to serve as protection from such conditions. Use for shade only. Disassemble and properly store your canopy after each use. **DO NOT** let snow or rain accumulate on top. Always use an anchoring system. Keep your canopy away from all fire sources. **DO NOT** machine wash your top. Mild soap & water with a brush while the canopy is open without the legs extended. **DO NOT** use harsh detergents or abrasives. **DO NOT** put away your Instant Canopy while wet or damp. This promotes mildew. Store DRY. For best results in keeping your top clean and avoiding small tears, it is recommended that top be removed and stored in carry bag after each use. **Never leave your canopy unattended!**

For missing parts, replacement parts or any questions:

Please email information@kingcanopy.com or call us between 8:00am – 5:00pm EST, Monday – Friday at **1-800-800-6296**

Replacement parts and customer service is also available through our website.

Please visit us at www.kingcanopy.com